



ORIGIN
ACOUSTICS®

TF 60 & 30 Series

ThinFit Collection

Installation Manual

TF64DT, TF36, TF34

Table of Contents

Introduction	1
Specifications	2
What's Included	3
Tools & Items	3
Wire Recommendation	3
Speaker Placement	4
About Speaker Wire	5
Installing the Wire	5
Wire Routing	6
Painting the Grille	7
Cutting the Hole	7
Connecting the Wire	8
Installing the Speaker	8
Installing the Grille	9
Testing & Adjustments	10
Installing the Grille	10
Troubleshooting	10
Technical Assistance	11
Warranty	12
Return Process	13

Introduction

Thank you for purchasing the ThinFit 60 & 30 In-Ceiling Speaker. At Origin Acoustics, we take pride in providing you with a high quality product. All of Origin Acoustics' speakers are designed to have excellent sound quality, longevity, and a simple installation process.

This instruction booklet covers the necessary information for a smooth installation, including: the tools you will need, step-by-step instructions for installation, troubleshooting tips for any errors that may occur, and all warranty information. If for any reason you experience problems or if you have installation questions please call us at (844) 674-4461. Hours of operation are 8:00am to 5:00pm (Pacific Time), Monday through Friday.

Specifications

Model	TF64DT	TF36	TF34
Part Number	STF2T6400	STF3600	STF3400
Woofer Cone	IMG	Fiber Glass	IMG
Woofer Diameter	6.5 (165mm)	3.5" (89mm)	3.5" (89mm)
Tweeter Dome	Aluminum	Silk DPSD	Aluminum
Tweeter Diameter	0.75" (20mm)	0.75" (20mm)	0.75" (20mm)
Frequency Response	45 Hz - 20 kHz	50 Hz - 20 kHz	55 Hz - 20 kHz
Impedance	8 ohm	8 ohm	8 ohm
Power Handling	5 - 140 Watts	5 - 110 Watts	5 - 90 Watts
Diameter	9.61 (244mm)	9.61 (244mm)	9.61 (244mm)
Grille Diameter	10" (254mm)	10" (254mm)	10" (254mm)
Cutout Diameter	8.75" (222mm)	8.75" (222mm)	8.75" (222mm)
Mounting Depth	2.75" (70mm)	2.68" (68mm)	2.68" (68mm)

What's Included

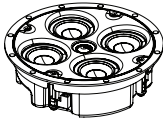

Speaker



Grille

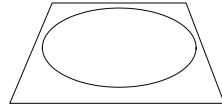

Template

Tools & Items

- Drywall Saw
- Speaker Wire
- Pencil
- Wire Stripper
- Measuring Tape
- Drill
- Drill Bit 1/8" (3mm)
- Stiff Wire
- Stud Finder
- Fish Tape
- Spray Paint
- Compressed Air

Wire Recommendation

The gauge of wire used can have an impact on the performance of your speakers. Use a multi-stranded wiring designed for amplifier to speaker connections. Which gauge to select depends on the length of wire to be used on any particular speaker. The longer your run is, the larger your wire size must be.

Wire Length	Wire Gauge
0 -100' (0 - 30m)	16
50 - 150' (15 - 45m)	14
Over 100' (30m)	12

Auxiliary Room (2 Speaker Placement)

Position the two speakers in the middle of the room, no less than 6' (2m) apart. Ideally, the two speakers would be placed an equal distance from the listener. If the room has a lower ceiling, the speakers can be closer together. Also, if the speaker placement is intended for standing (as opposed to sitting) listeners, the speakers can be closer together.

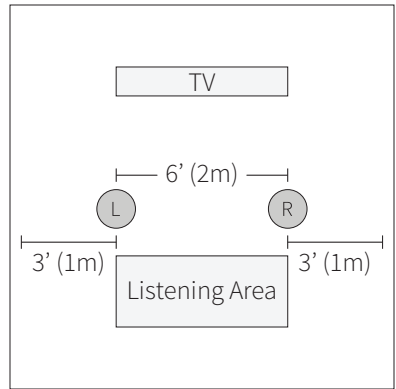

Home Theater (5 Speaker Placement)

The Left Rear (LR) and Right Rear (RR) speakers should be installed just behind the listener, one on either side. The Center Channel (CC) speaker should be placed above and slightly in front of the television, with the Left Front (LF) and Right Front (RF) speakers placed equidistant to either side.

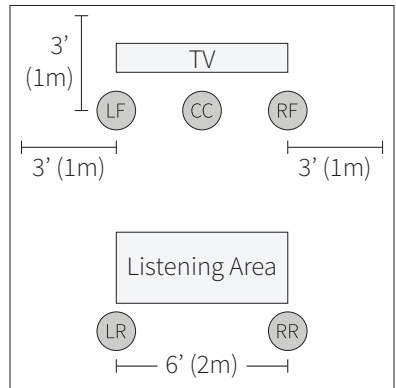

About Speaker Wire

You will need a wire that has at least two conductors; one that can be identified as the positive and the other as the negative. All two conductor wires have some means of identifying which conductor is which, but at times this identification may be subtle. It's crucial that you keep track of which wire you use for positive (+) and negative (-). Typically if the wires are colored red and black, the red wire is used for positive and the black wire is used for negative, but sometimes other colors or patterns are used. You can choose whichever color of wire you want to be positive and negative as long as you remain consistent throughout the install.

On both your amplifier and your speaker the connectors will be identified as red for positive and black for negative. It is very important to look carefully at the speaker wires and be certain that the same wire that is attached to the positive connector in the amplifier is attached to the positive connector in the speaker.

1. Installing the Wire

Strip $\frac{1}{4}$ to $\frac{1}{2}$ inches (6 to 12 mm) of the insulation off both ends of the wire. To avoid stray strands, twist them at the end. Connect the wire to the amplifier, and make sure the wire connected to the left speaker output will be routed to the left speaker, right output to right speaker, etc.

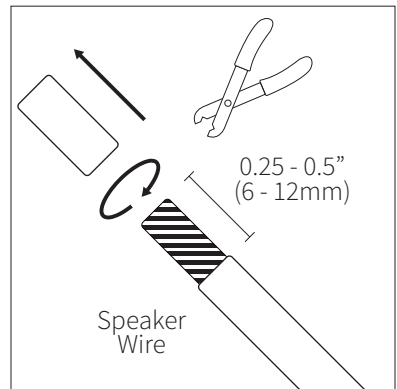

Wire Routing

Plan how you'll route the wire to the desired speaker location. There are several methods for routing the wire, and you may need to combine several of them.

Behind the Baseboard

The wire can be routed behind the baseboard by cutting a groove out of the back of the baseboard, or by buying special baseboard designed for concealing wires.

Through Walls

When running wires through a wall, be sure to avoid all obstacles such as AC wiring, pipes, and ducts.

Attic or Basement

When available, you can route the wire through an attic or crawlspace.

Under the Carpet

One option is to lift up the carpet and route "tape wire" under the carpet.

For New Construction

If these speakers are being installed in a new home during construction, the installation process will be a bit different (although much simpler). For these situations, it's recommended you purchase a bracket. Instructions on how to install the speakers are provided with the bracket, or can be found on our website. Visit www.originacoustics.com for more information.

2. Painting the Grille

In some situations the speakers may look better if the color matched the walls, ceiling, or trim in the room. This can be accomplished by painting the grille. The grille must be painted with spray paint, and most hardware stores will mix a can of paint to match whatever color you need. Before painting, carefully remove the thin cloth on the underside of the grille. Lightly spray the front of the grille with the paint from a distance, being careful not to plug any of the holes. Diluting the paint with paint thinner will lessen the risk of filling any holes. If a hole gets plugged use a can of compressed air to open it. Once the paint is dry, put the cloth back on the grille.

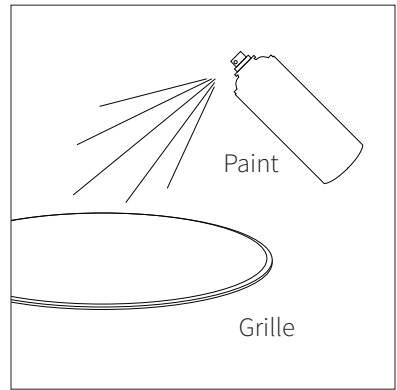
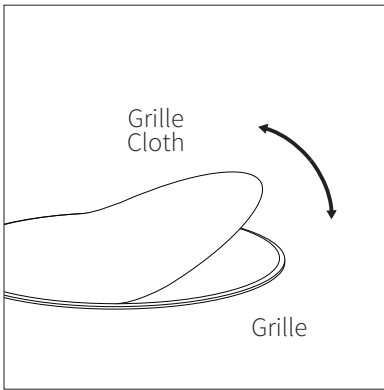

3. Cutting the Hole

When you've decided on the locations for all of the speakers, use the template to trace a circle lightly in pencil where the hole should be. (If you don't have a tem-

plate, check the Specifications section for cutout sizes.) If you're unsure on whether there may be obstacles (such as pipes or wires) where you plan on installing the speaker, drill a 1/8 inch hole in the center of the circle, then put a bent coat hanger through the hole to feel around. Use a keyhole or drywall saw to cut the hole.

4. Connecting the Wire

Insert the wires into the connectors, making sure that the positive wire is being attached to the red connection and the negative wire is being attached to the black connection. If the negative and positive wires are switched, speaker performance will be drastically impacted.

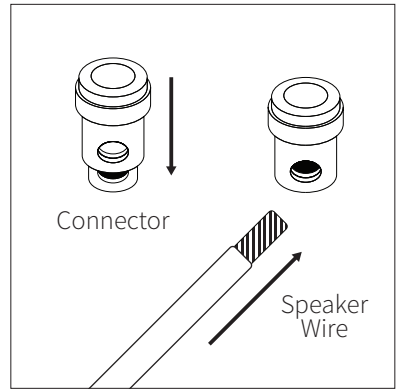

5. Installing the Speaker

Make sure all the dogs are in the upright position and facing to the side, not outwards. Insert the speaker into the hole. Turn the four screws so that the dogs face outwards and continue turning until they clamp down on the ceiling. When you feel resistance, stop tightening the screws.

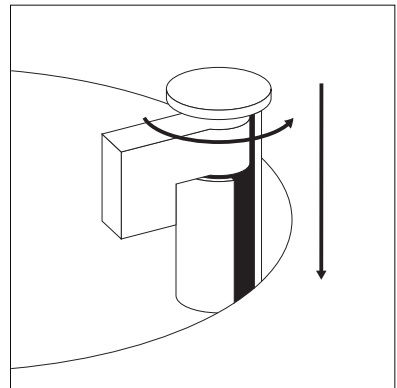

6. Installing the Grille

Fit the grille over the speaker. The grille uses magnets to be held in place.

Troubleshooting

If possible, it's often good to try to isolate the problem first. For example, if you're playing a DVD on a television and there's no sound, try connecting an MP3 player to the system to see if that works. If it does work, then the problem is with the television, DVD player, or the cables connecting them. If it doesn't work, the problem will be with the amplifier, speakers, or those cables.

Problem	Possible Cause
No Sound	The volume may be turned down or muted. Check the volume settings on both the amplifier and the television/computer/CD player/etc.
No Sound	Make sure the proper source is selected on the amplifier or receiver.
No Sound	Check the cord connecting the amplifier with the source. The cord may be damaged or plugged into the wrong input or output.
No Sound	Check the wires connecting the amplifier with the speakers. Make sure they're connected properly and not damaged in any way.
Poor Sound Quality	If you hear something like static, or the sound is cutting in and out, check the audio cables. If the problem increases when a cable is being moved, then the cable is most likely faulty or not connected properly.
Poor Sound Quality	Today's audio systems may have several places to adjust the volume, for example your MP3 player may have a volume control, and your amplifier may also have one. Check to be certain that the volume isn't turned up past 80% on any device.
Poor Sound Quality	Try changing sources to be certain that the selection you've chosen is a good quality recording.

Technical Assistance

If you have any questions or concerns about installing or using this product, you can reach us through one of the following methods:

Phone: (844) 674-4461

Hours of operation: 8:00am - 5:00pm (Pacific Time), Mon - Fri

Email: techsupport@originacoustics.com

If you are having technical trouble, please include the model number and briefly explain what steps you took to resolve the problem in your email, or be prepared to answer these questions over the phone. If you are considering returning the product, it's required that you contact Origin Acoustics prior to any return attempts. This way we can determine if the issue can be resolved without returning the product, or if needed we can provide instructions and support for the return process.

Limited Lifetime Warranty

Origin Acoustics warrants to the original retail purchaser only that this Origin Acoustics product will be free from defects in materials and workmanship, provided the speaker was purchased from an Origin Acoustics authorized dealer.

If the product is determined to be defective, it will be repaired or replaced at Origin Acoustics' discretion. If the product must be replaced yet it is no longer manufactured, it will be replaced with a model of equal to or greater value that is the most similar to the original. If this is the case, installing the replacement model may require mounting modifications; Origin Acoustics will not be responsible for any such related costs.

Requirements & Warranty Coverage

This warranty may not be valid if the product was purchased through an unauthorized dealer. This warranty only applies to the individual that made the original purchase, and it cannot be applied to other purchases. The purchaser must be prepared to provide proof of purchase (receipt). This warranty will not be valid if the identifying number or serial number has been removed, defaced, or altered.

Not Covered by Warranty

- Accidental damage
- Damage caused by abuse or misuse
- Damage caused by attempted repairs/modifications by anyone other than Origin Acoustics or an authorized dealer
- Damage caused by improper installation
- Normal wear, maintenance, and environmental issues
- Damage caused by voltage inputs in excess of the rated maximum of the unit
- Damage inflicted during the return shipment

Return Process

Before making any return attempts, it is required that you first contact Origin Acoustics. Return product to Origin Acoustics or your dealer, either in person or by mail. It's preferable if the product is returned in the original packaging. If this isn't possible, the customer is responsible for insuring the shipment for the full value of the product.

This warranty is in lieu of all other expressed or implied warranties. Some states do not allow limitations on implied warranties, so this may not apply depending on the customer's location. (For more information, see Magnuson-Moss Warranty Act.)



www.originacoustics.com • 844-674-4461

©2017 Origin Acoustics